

CS CO., LTD.

Rev.1.4

DELOLW\

ELECTRICAL CHARACTERISTICS 5DWLQJ DDP ELHQW WHP SHU B WK H U ZX Q B H V S H F

Parameter	Symbol	Min.	Typ.	Max.	Unit
)RUZDUG YROWDJH 3LQ a RU 3LQ a	9)				9
) \$ 7					
5HYHUVH FXUUHQW 3LQ a RU 3LQ a	5				\$
9 7					

ORDERING INFORMATION

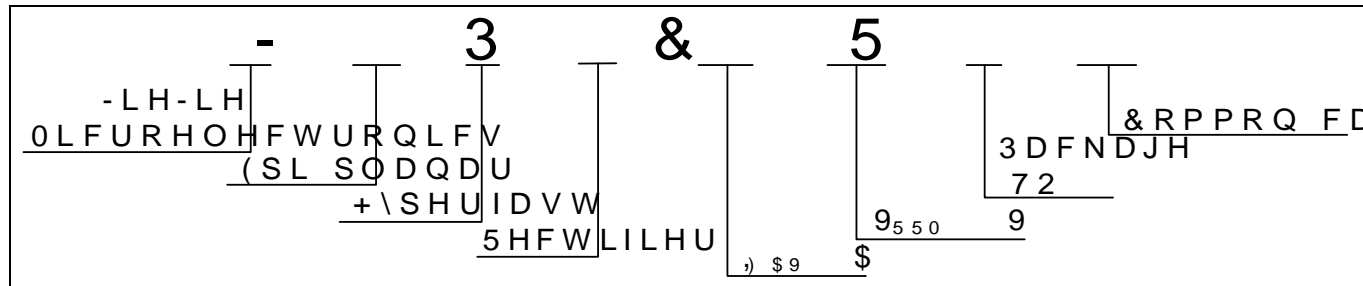

PACKAGE MECHANICAL DATA

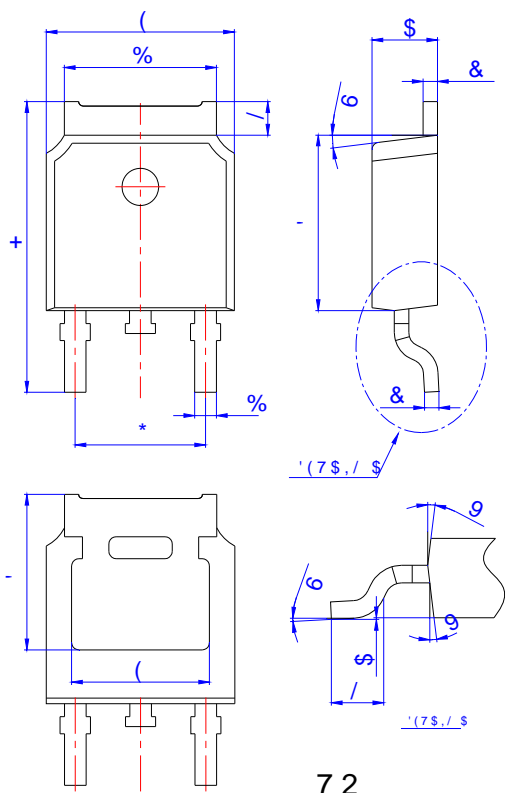

5HI	'LPHQVLRQV					
	0LOOLPHWHUV ,QFKHV					
	0LQ	7\S	0D[	0LQ	7\S	0D[
\$						
\$						
%						
%						
&						
&						
'						
'	5 ( )			5 ( )		
(						
(						
*						
+						
/						
/						
9		f			f	
9	f		f	f		f

REEL SPECIFICATION -TO-252

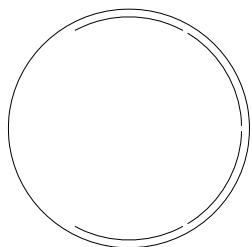

5 HI	'LPHQVLRQV	
	0LOOLPHWHUV	
:	0D[	0D[
(	"	"
)	"	"
'	"	"
'	0LQ	0LQ
3	"	"
3	"	"
3	"	"
\$	"	"
%	"	"
.	"	"
7	"	"

,QFKHV

CHARACTERISTICS CURVE

), \* 7 \ SLFDO IRUZDUG FKD 3LQ a RU 3LQ a      ), \* 7 \ SLFDO UHYHUVH FKD 3LQ a RU 3LQ a

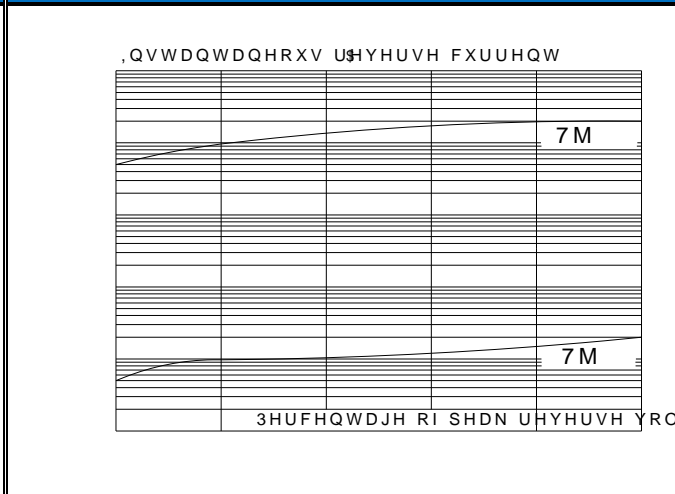
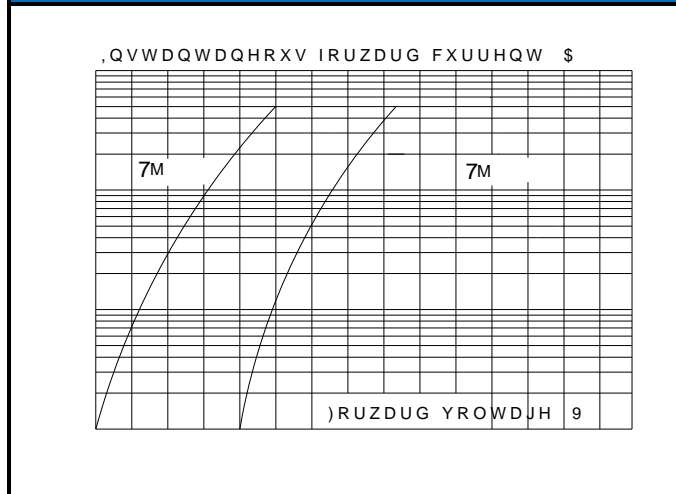

), \* 0D[LPXP QRQHSBWDUWUZL FXUUHQW PV VLQJOH KDUI 3LQ a ZDU

), \* 0D[LPXP QRQHSBWDUWUZL FXUUHQW PV VLQJOH KDUI 3LQ a ZDU

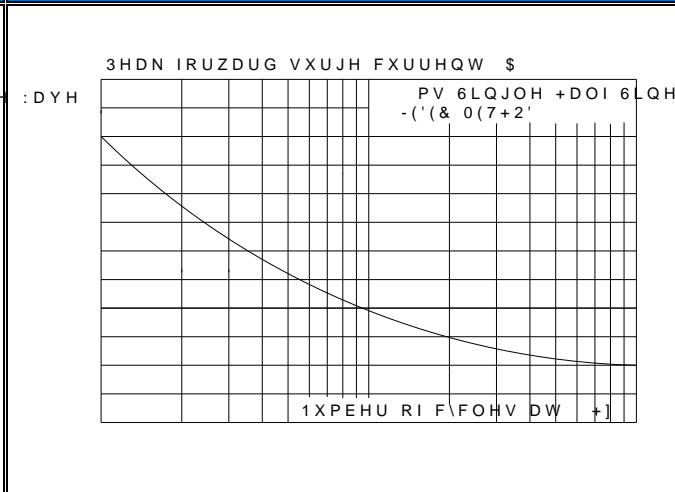
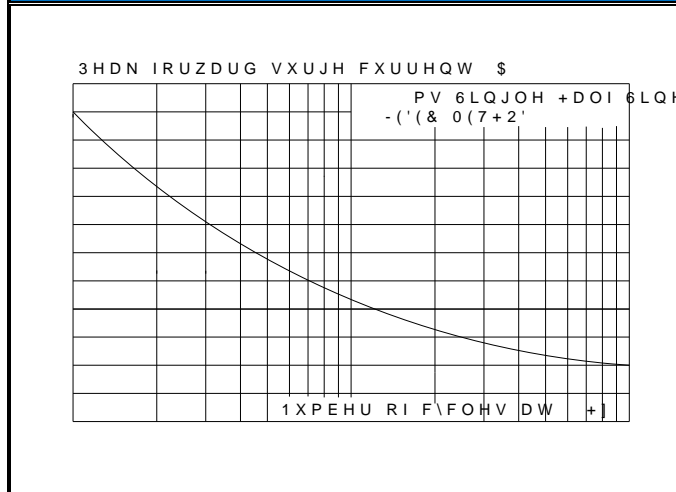

), \* )RUZDUG FXUUHQW GHU 3LQ a

), \* 5HYHUVH UHGRILQLW

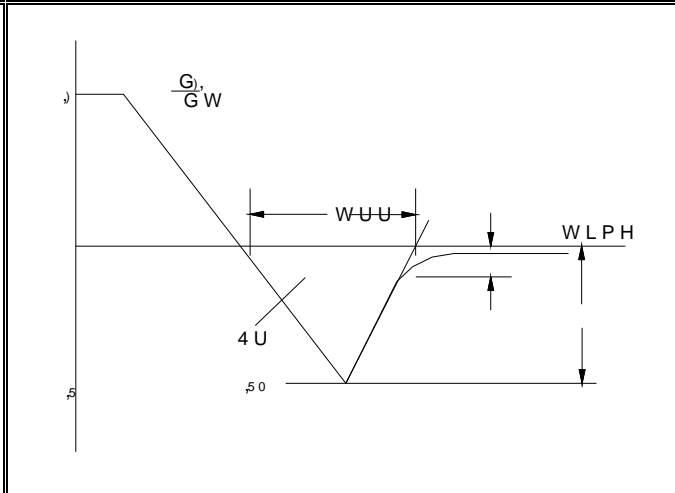
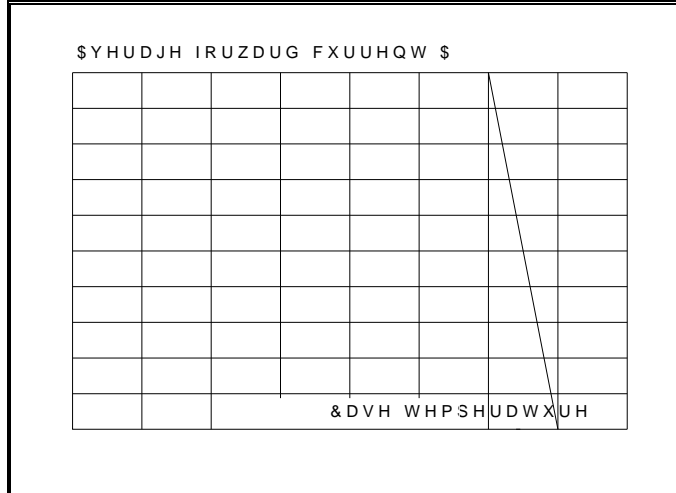

-LH-LH SURGXFWV DLRUQRWGGWKDOOHCERQW SXUSRVHGUQDFZLWK  
 OLPLWDWLRQ DIXOLRPRUWLPHGRVSDQDLCHLHDYKVWDLQLQJ RU  
 DSSOLFDWLRQV GHYLFHV LQWHQGHC\IRU VXUJRWDGU LPSODQ  
 ZKLFK WKH IDLOGXWHLBHGGBSNURDWLRQ\RIHWKGVSRGSXFWWRQDC  
 GHDWK RU SURSHUVKDQDPRBRMHFM\SKWHLWQDSSEWFDFLWMK-LH-LH  
 GRFXPHQWDWLRQ :DBU DLQWILH W K D D Q VSHHGUHSPRGXYRVLV XVHG  
 SXUSRVH QRW H[SUHDV\SO LFDLHOB B WKEBQ W-LW-LH VKDOO QRW  
 DQ\FODLPV RU GDPVJRM SURLGXQWRXRQHGQRWD BSSULFDWQ\ LQ  
 -LH-LH DV VHW IRU-WK-LBGBSOPFDQVQXVHKHRVDOH-LH SUR  
 VXEMHFW WR -LH-LH WHUPV DQG FRQGLVWULRQG/ERI-VBOLH XQO  
 ,QIRUPDWLRQ IXUQXFKBQ\LOVWKOVHGYMFB DORGEWHHDFDXEUDH +RZ  
 -LDQJVVX -LH-LH OLBURRHOWHGFWDVROXLFHVQLRVUHRVSRQVHLERQVHTX  
 XVH ZLWKRXW FRQVKGHLQJWBWBQURQQRU XVH EH\RQG L  
 MDQAHQWCHG DQRH BXTE @V@ \0n °"FÀÀp,QPR@ BOPPVG