



**JEUR6004SL**  
**EPI ULTRAFAST RECOVERY RECTIFIER**

Rev.1.6

**DESCRIPTION**

Plastic package has underwriters laboratory flammability classification 94V-0  
Lead free in comply with EU RoHS 2011/65/EU directives  
Low reverse leakage current  
Ultrafast recovery time and soft recovery characteristics  
Low recovery loss

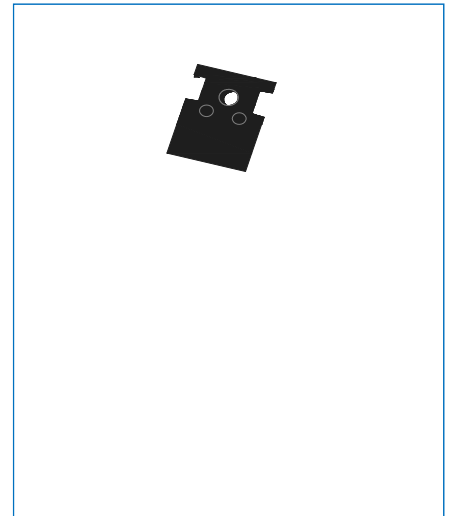

**MECHANICAL DATA**

Case: TO-247J-2L molded plastic  
Terminals: Solder plated, solderable per J-STD-002  
Weight:5.75gram

**ABSOLUTE MAXIMUM RATING** (Rating at 25 ambient temperature unless otherwise specified.)

| Parameter  | Symbol         | JEUR6004SL  | Unit |
|--|----------------|-------------|------|
| Maximum repetitive peak reverse voltage  | $V_{RRM}$      | 400         | V    |
| Maximum DC blocking voltage  | $V_{DC}$       | 400         | V    |
| Average forward current at $T_{mb}=125$  | $I_{F(AV)}$    | 60          | A    |
| Peak forward surge current: 8.3ms single half sine-wave superimposed on rated load | $I_{FSM}$      | 600         | A    |
| Junction temperature and storage temperature range                                 | $T_j, T_{stg}$ | -55 to +150 |      |

**ELECTRICAL CHARACTERISTICS**(Rating at 25 ambient temperature unless otherwise specified.)

| Parameter             |   | Symbol   | Min. | Typ. | Max. | Unit    |
|-----------------------|---|----------|------|------|------|---------|
| Forward voltage       | $I_F=60A, T_j=25$                           | $V_F$    | -    | 1.15 | 1.45 | V       |
|                       | $I_F=60A, T_j=150$                          |          | -    | 0.95 | 1.35 |         |
| Reverse current       | $V_R=400V, T_j=25$                          | $I_R$    | -    | -    | 5    | $\mu A$ |
|                       | $V_R=400V, T_j=150$                         |          | -    | -    | 500  |         |
| Reverse recovery time | $I_F=0.5A, I_R=1A, I_{rr}=0.25A$            | $t_{rr}$ | -    | 55   | 75   | ns      |
|                       | $I_F=1A, V_R=30V, di/dt=200A/\mu s, T_j=25$ |          | -    | 29   | 45   |         |

**THERMAL RESISTANCES**

| Symbol         | Parameter   | Min. | Typ. | Max. | Unit |
|----------------|---|------|------|------|------|
| $R_{th(j-a)}$  | Thermal resistance from junction to ambient       | -    | 40   | -    | /W   |
| $R_{th(j-mb)}$ | Thermal resistance from junction to mounting base | -    | -    | 1    | /W   |

**MARKING**

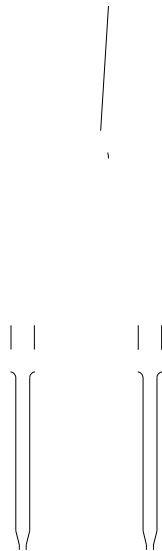

**PACKAGE MECHANICAL DATA**

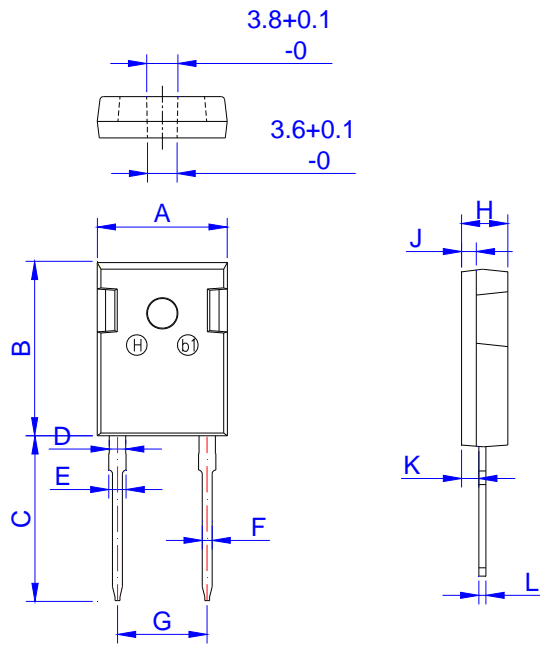

| Ref. | Dimensions  |       |       |        |       |       |
|------|-------------|-------|-------|--------|-------|-------|
|      | Millimeters |       |       | Inches |       |       |
|      | Min.        | Typ.  | Max.  | Min.   | Typ.  | Max.  |
| A    | 15.50       | 15.80 | 16.10 | 0.610  | 0.622 | 0.634 |
| B    | 20.80       | 21.00 | 21.20 | 0.819  | 0.827 | 0.835 |
| C    | 19.70       | 20.00 | 20.30 | 0.776  | 0.787 | 0.799 |
| D    | 1.80        | 2.00  | 2.20  | 0.071  | 0.079 | 0.087 |
| E    | 1.90        | 2.10  | 2.30  | 0.075  | 0.083 | 0.091 |
| F    | 1.00        | 1.20  | 1.40  | 0.039  | 0.047 | 0.055 |
| G    | 10.50       |       | 11.30 | 0.413  |       | 0.445 |
| H    | 4.80        | 5.00  | 5.20  | 0.189  | 0.197 | 0.205 |
| J    | 1.90        | 2.00  | 2.10  | 0.075  | 0.079 | 0.083 |
| K    | 2.20        | 2.35  | 2.50  | 0.087  | 0.093 | 0.098 |
| L    | 0.41        | 0.60  | 0.79  | 0.016  | 0.024 | 0.031 |

TO-247J-2L

**PACKAGE INFORMATION-TO-247J-2L**

| OUTLINE | UNIT WEIGHT<br>(g/PCS) TYP | TUBE<br>(PCS) | PER CARTON<br>(PCS) |
|---------|----------------------------|---------------|---------------------|
| TUBE    | 5.75                       | 30            | 2,250               |

CHARACTERISTICS CURVE

FIG.1: Typical forward characteristics

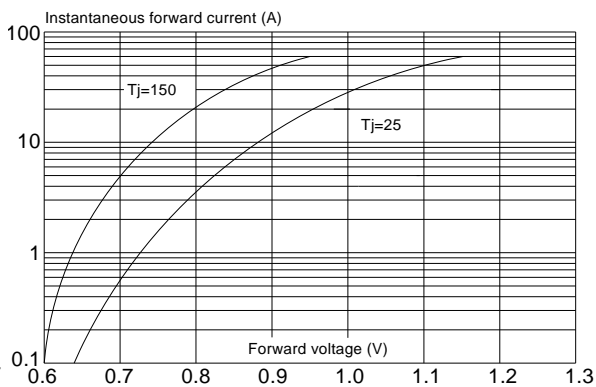

FIG.2: Typical reverse characteristics

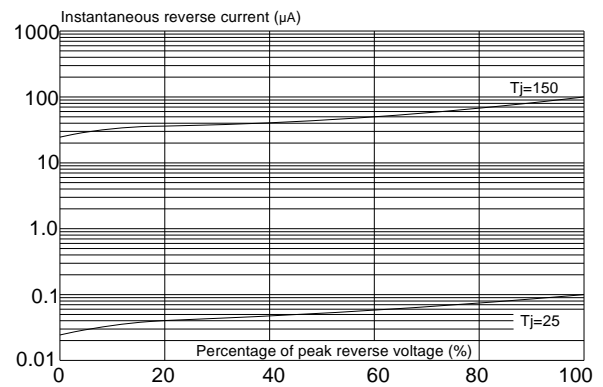

FIG.3: Maximum non-repetitive peak forward surge current(8.3ms single half sine-wave)

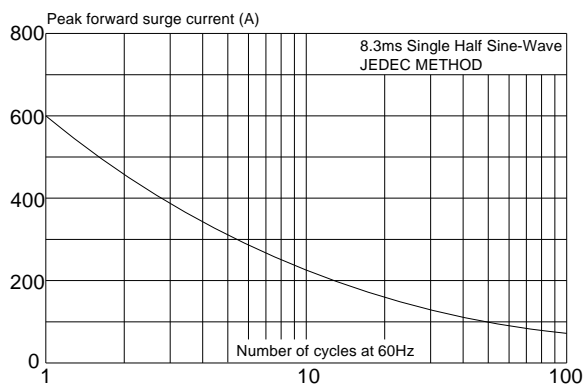
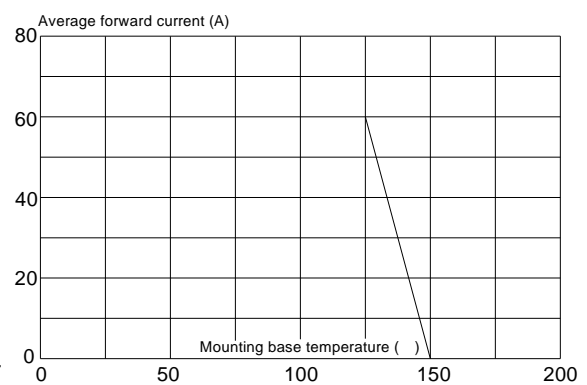

FIG.4: Forward current derating curve



JieJie products are not designed for, and shall not be used for, any purpose (including, without limitation, automotive, military, aerospace, medical, life-saving, life-sustaining or nuclear facility applications, devices intended for surgical implant into the body, or any other application in which the failure or lack of desired operation of the product may result in personal injury, death, or property damage) other than those expressly set forth in applicable JieJie product documentation. Warranties granted by JieJie shall be deemed void for products used for any purpose not expressly set forth in applicable JieJie documentation. JieJie shall not be liable for any claims or damages arising out of products used in applications not expressly intended by JieJie as set forth in applicable JieJie documentation. The sale and use of JieJie products is subject to JieJie terms and conditions of sale, unless otherwise agreed by JieJie.

Information furnished in this document is believed to be accurate and reliable. However, Jiangsu JieJie Microelectronics Co., Ltd. assumes no responsibility for the consequences of use without consideration for such information nor use beyond it.

Information mentioned in this document is subject to change without notice, apart from that when an agreement is signed, Jiangsu JieJie complies with the agreement.

Products and information provided in this document have no infringement of patents. Jiangsu JieJie assumes no responsibility for any infringement of other rights of third parties which may result from the use of such products and information.

This document is the 1.6th version which is made in 10-July-2025. This document supersedes and replaces all information previously supplied.

 is a registered trademark of Jiangsu JieJie Microelectronics Co., Ltd.

Copyright ©2025 Jiangsu JieJie Microelectronics Co., Ltd. Printed All rights reserved.