

-67 8 6: \$ 75, \$ &

5HY \$

^ Z/Wd/KEW

7KH -67 8 6: W X L W F D E O H V I R U J H Q H U D O S X U S R V H
\$ & V Z L W F K L Q J , W F D Q E H X V H G D V D Q 2 1 2)) I X Q F W L R Q L Q
D S S O L F D W L R Q V V H F X O D W K R Q W L Q G X F W L R Q P R W R U
V W D U W L Q J F L U F R Q W W V R I O R U S H K U D D W L R Q L Q O L J K W
G L P P H U V P R W R U V S H H G F R Q W U R O O H U V -67 8 6:
V Q X E E H U O H V V W O O D E H L F R H P P S H O F L H G I R U X V H R Q
L Q G X F W L Y H O R D G H Q G W L F H D Q W E H V K U R X J K W K H 0 & 8 , 2
S R U W & R P S O \ L Q Q Q D W G V 8 /) V W H U H I (
3 D F N D J H 7 2 L V 5 R + 6 F R P S O L D Q W

D / E & dhZ ^

^K>hd D y/DhD Z d/E'^

3DUDPHWHU	6\PERO	9DOXH	
6WRUDJH MXS\FWDLRQWHLDPQJH VWJ		7	
2SHUDWLQJWHFOSHWLDROXUH	UDQMH	7	
5HSHWLWLYH SHDN RMI VWDWH 50R	OWDJH	7	9
5HSHWLWLYH SHDN WHYHUVH 95R	OWDJH	7	9
506 RQ VWDWH&FXUUHQW 7	,7 506		
1RQ UHSHWLWLYH VXUJH SHDN RQ VWDWH FXUUHQW IXOO Fs\FPH MW			\$
1RQ UHSHWLWLYH VXUJH SHDN RQ VWDWH FXUUHQW IXOO Fs\FOPV W7	760		\$
,W YDOXH IRU PXVLMQJ W	,W		\$ V

8QLV

&ULWLFDO BDWG RWDWHHFXUUHQW
; h,*7 l +]m 7 G, G < ð, 0"1 'ñD#g8,l @ €•H!gxP H

-67 8 6:

-LH-LH 0LFURHOHFWURQL

3HDN JDWH SRZHU	3*0		
3HDN SXOVH YROWDJH 7M QRQ UHSHWLWLYH RII	9SS VWDWH), *		

:
NE

> dZ/ > , Z d Z^d/ XQOHVV RWKHUZLVH VSHFLILHG

8\PERO	7HVW &RQGLWLRQ	4XDGUDQW	9DOXH
--------	----------------	----------	-------

-67 8 6:

-LH-LH 0LFURHOHFWURQL

KZ Z/E' /E&KZD d/KE

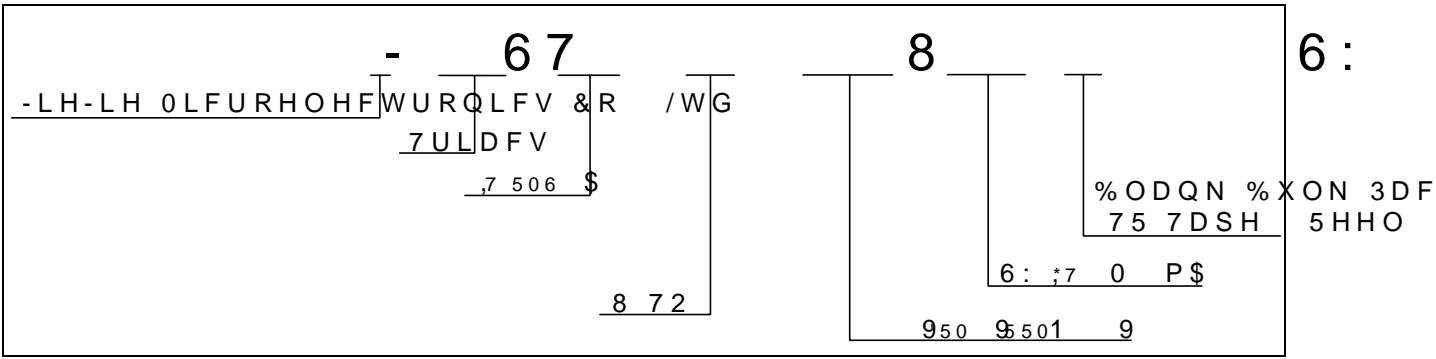

D Z</E'

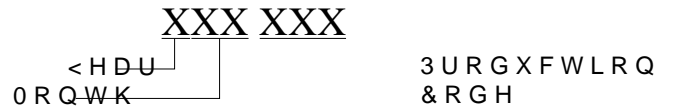
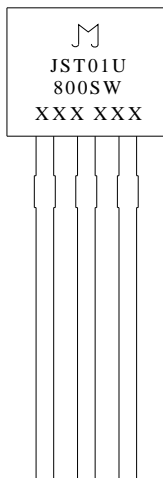

ixó

i

ixí

), * Ö7HVW FLUFXLW IRU LQGXFWLYH DQG UMVQGDUGV OF

, (& 6WDQGDUGV
6XUJH *HQHUDWRU
6YROWDJH VXUJH
6FXUUHQW VXUJH

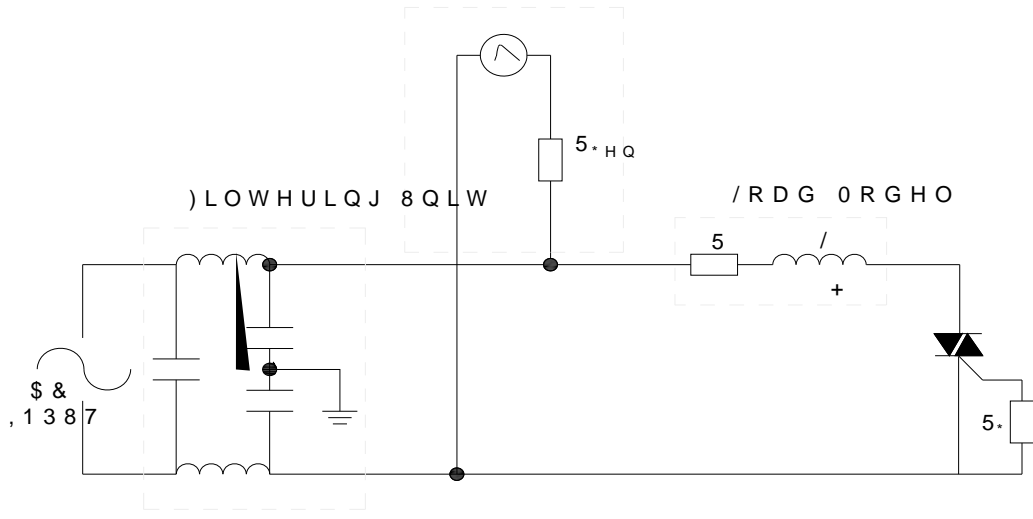

KZ Z/E' /E&KZD d/KE

2UGHU FRG	9ROWD 9 ₅₀ 9 ₅₀ 9	,*7 P\$	3DFNDJH	%DVH SFV	'HOLYHU\ PRGH
-67 8 6:			72		%XON 3DFN
-67 8 6: 75					7DSH 5HHO

'RFXPHQW 5HYLVLRQ +LVWRU\

'DWH	5HYLVLRQ	&KDQJHV
\$SU	\$	/DVW XSGDWHG
ODU	\$	5HQH\$&.\$*(0(&+\$1,&\$/ '\$7\$
6HSW	\$	5HYLVLRQ\$&.\$*(0(&+\$1,&\$/ '\$7\$

W < ' D , E / > d

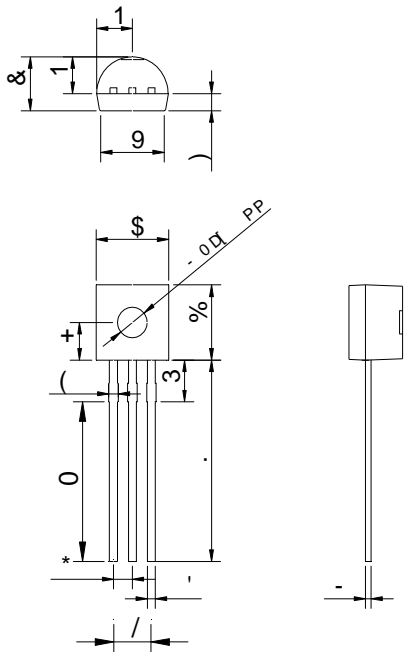

5HI	'LPHQVLRQV					, QFKHV
	0LOOLPHWHUV					
	0LQ	7\S	0D[0LQ	7\S	
\$						
%						
&						
'						
(
)						
*						
+						
-						
.						
/						
0						
1						
3						
9						

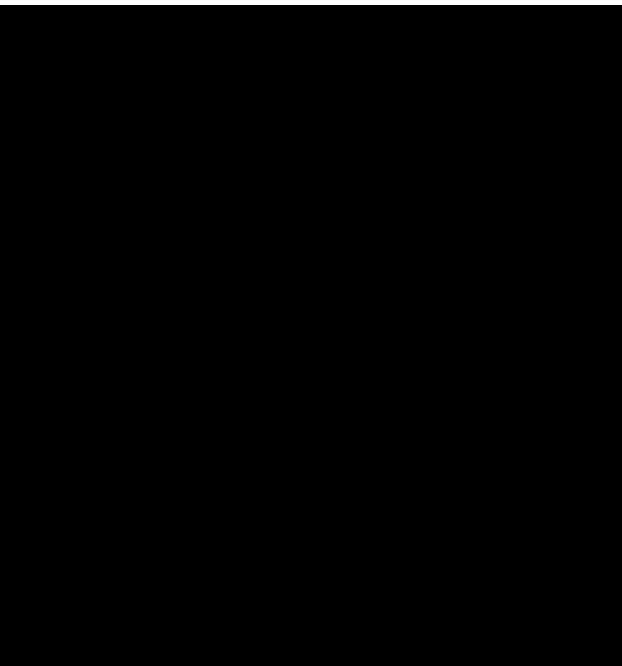

	%\$* 3 & 6	, 1 1 (5 % 2 ; 3 & 6	& \$ 5 7 2 1 % 2 ; 3 & 6
3 D F N			

'LPHQVLRQV

5HI 0LOOLPHWHUV ,QFKHV
 0LQ 7\ S 0D[0LQ 7\ S 0D[
 3
 3 s ^
 3 G
 3
 , 3
) A)
))
 :
 :
 :
 :
 , +
 /
 +

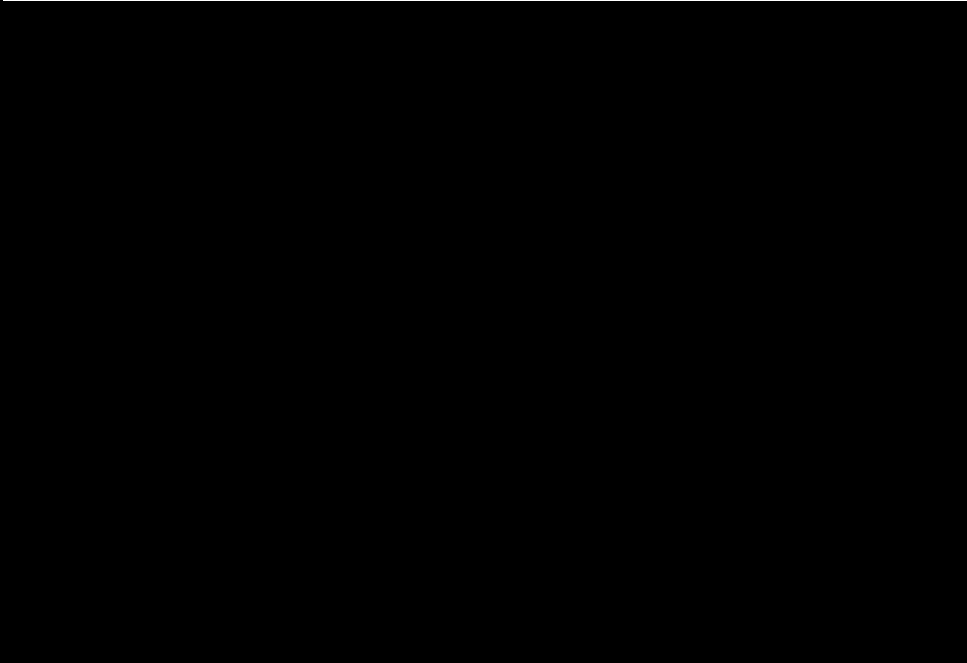
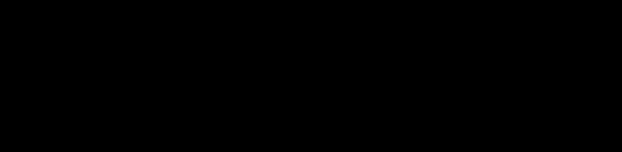

,QIRUPDWLRQ IXUQXPHQW ILQ WKOLHGRHG WR EH DFFXUDWH
 -LDQJVX -LH-LH 0LRRHOWHG WDVROLFHV OLWU HRUS ROKH ERQVH
 RI XVH ZLWKRXW FRQVLGHUDWLRQ IRG MWFKQIQURPDPDWRLOQ
 PHQWLRQH G LQ WKXVGRFWPMQW KDVQ JB SZLWK RXPQV RKLW HZ
 DJUHHPHQW LV VLJQLHGFREDSQLWX -ZLHWK WKH DJUHHPHQW