



**ACJP01W-800SW 1A TRIAC**

Rev.A.1.1

**DESCRIPTION:**

The ACJP01W-800SW triac is suitable for general purpose AC switching. It can be used as an ON/OFF function in applications

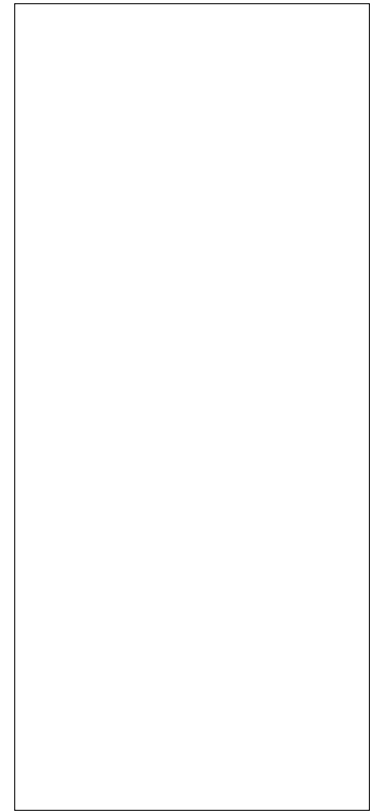

3

Average gate power dissipation ( $T_j=125$ )	$P_{G(AV)}$	0.1	W
Peak gate power	$P_{GM}$	2	W
Peak pulse voltage ( $T_j=25$ ; non-repetitive, off-state; FIG.8)	$V_{pp}$	4.5	kV

**ELECTRICAL CHARACTERISTICS** (unless otherwise specified)

Symbol	Test Condition	Quadrant	Value		Unit
$I_{GT}$	$V_D=12V$ $R_L=33$	-	MAX.	10	mA
$V_{GT}$		-	MAX.	1	V
$V_{GD}$	$V_D=V_{DRM}$ $T_j=125$ $R_L=3.3k$	-	MIN.	0.15	V
$I_L$	$I_G=1.2I_{GT}$		MAX.	25	mA
				10	
$I_H$	$I_T=100mA$		MAX.	10	mA
$dV/dt$	$V_D=540V$ Gate Open $T_j=125$		MIN.	100	V/ $\mu s$
$(dI/dt)_c$	$(dV/dt)_c=10V/\mu s$ , $T_j=125$		MIN.	0.6	A/ms
$t_{on}$	$I_G=20mA$ $I_A=200mA$ $I_R=20mA$ $T_j=25$		TYP.	2.5	$\mu s$
$t_{off}$				25	
$V_{CL}$	$I_{CL}=0.1mA$ $t_p=1ms$		MIN.	900	V

**STATIC CHARACTERISTICS**

Symbol	Parameter		Value(MAX.)	Unit
$V_{TM}$	$I_{TM}=1.1A$ $t_p=380\mu s$	$T_j=25$	1.3	V
$V_{TO}$	Threshold voltage	$T_j=125$	0.77	V
$R_D$	Dynamic resistance	$T_j=125$	276	m
$I_{DRM}$	$V_D=V_{DRM}$ $V_R=V_{RRM}$	$T_j=25$	5	$\mu A$
$I_{RRM}$		$T_j=125$	0.4	mA

**THERMAL RESISTANCES**

Symbol	Parameter	Value	Unit
$R_{th(j-c)}$	junction to case (AC)	25	$^{\circ}W$
$R_{th(j-a)}$	junction to ambient (AC)	150	$^{\circ}W$

ORDERING INFORMATION

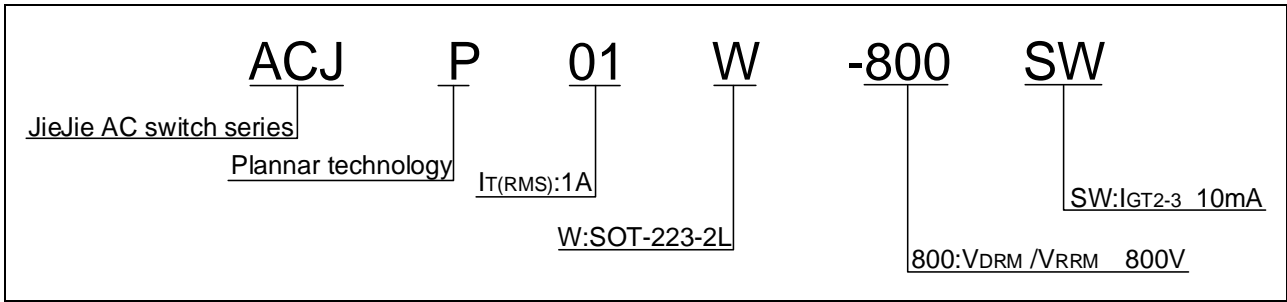

MARKING

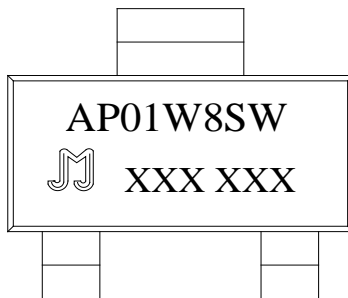

**FIG.1:** Maximum power dissipation versus RMS on-state current

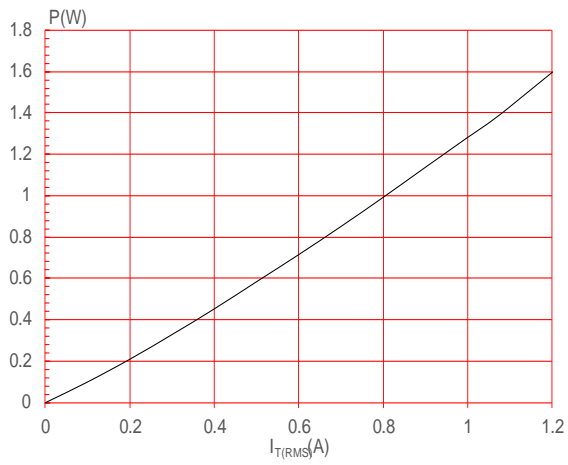

**FIG.2:** RMS on-state current versus case temperature

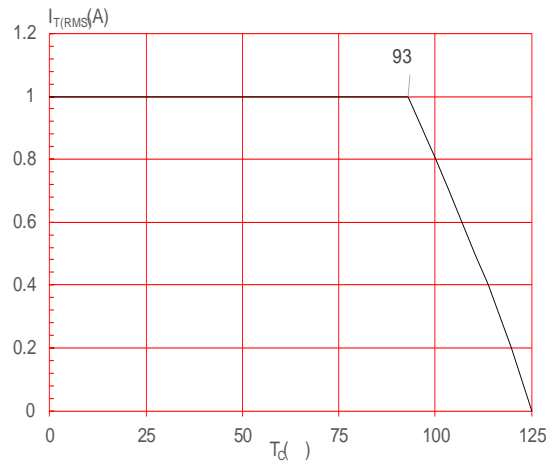

FIG.7: Relative variations of gate trigger current, holding current and latching current versus junction temperature

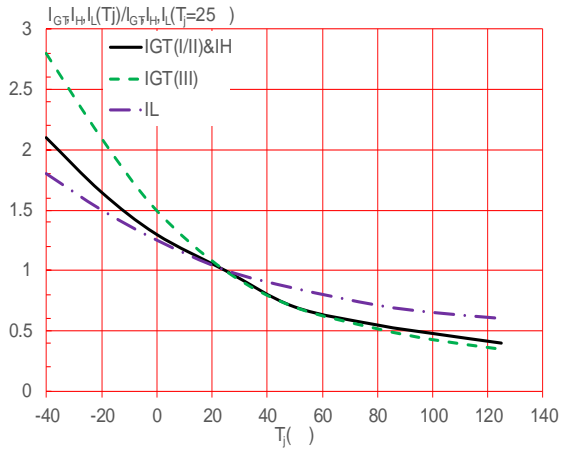
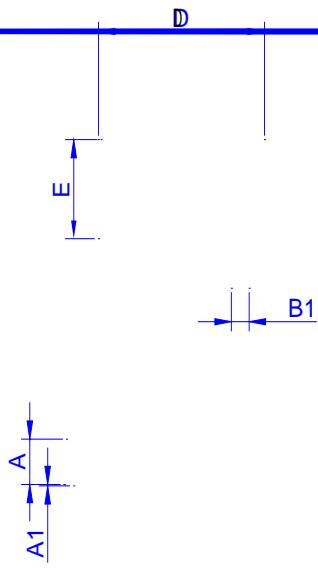

FIG.8 Test circuit for inductive and resistive loads to IEC-



PACKAGE MECHANICAL DATA



DELIVERY MODE

Ref.	Dimensions Millimeters
------	---------------------------

Information furnished in this document is believed to be accurate and reliable. However, Jiangsu JieJie Microelectronics Co., Ltd. assumes no responsibility for the consequences of use without consideration for such information nor use beyond it. Information mentioned in this document is subject to change without notice, apart from that when an agreement is signed, Jiangsu JieJie complies with the agreement.

Products and information provided in this document have no infringement of patents. Jiangsu JieJie assumes no responsibility for any infringement of other rights of third parties which may result from the use of such products and information. This document supersedes and replaces all information previously supplied.



is a registered trademark of Jiangsu JieJie Microelectronics Co., Ltd.

Copyright © 2025 Jiangsu JieJie Microelectronics Co., Ltd. All rights reserved.