





FIG.1: 
0 

FIG.2:  - 

000-4 5 8
1.2/50 μ S voltage surge
8/20 μ S current surge



AM

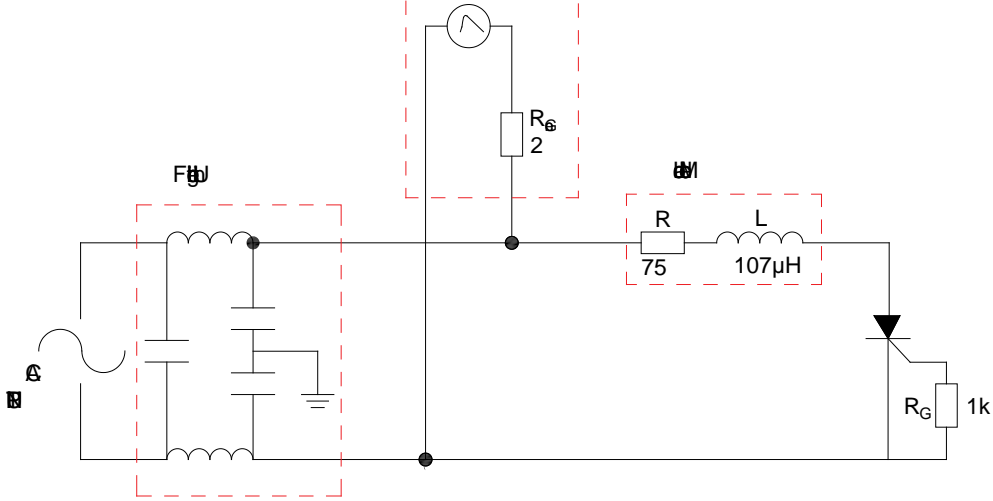
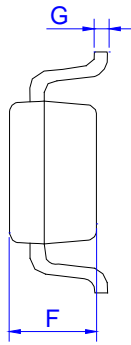
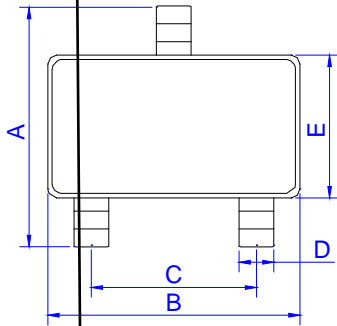

R	B					
	M			lb.		
	M	\bar{p}	M	M	\bar{p}	M
A	2		2	0		0
B		2			0	
C		1			0	
D	0		0	0		0
E		1			0	
F		1			0	
G		0			0	
H	0					

