

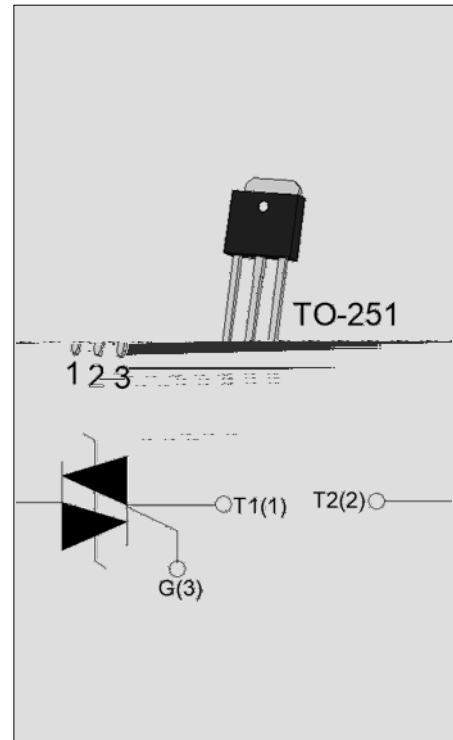


## ACJT425-10H 4A TRIAC

Rev.A.1.1

### DESCRIPTION:

The ACJT425-10H triac is suitable for general purpose AC switching. It can be used as an ON/OFF function in applications such as heating regulation, induction motor starting circuits, for phase control operation in light dimmers, motor speed controllers. The ACJT425-10H embeds a TVS structure to absorb the inductive turn-off energy such as those described in the IEC 61000-4-5 standards. Package TO-251 is RoHS compliant.



### MAIN FEATURES

Symbol	Value	Unit
$I_{T(RMS)}$	4	A
$V_{DRM}/V_{RRM}$	1000	V
$I_{GT} / /$	25/25/25	mA

### ABSOLUTE MAXIMUM RATINGS

Parameter	Symbol	Value	Unit
Storage junction temperature range	$T_{stg}$	-40-150	
Operating junction temperature range	$T_j$	-40-125	
Repetitive peak off-state voltage ( $T_j=25^\circ C$ )	$V_{DRM}$	1000	V
Repetitive peak reverse voltage ( $T_j=25^\circ C$ )	$V_{RRM}$	1000	V
RMS on-state current ( $T_c = 99^\circ C$ )	$I_{T(RMS)}$	4	A
Non repetitive surge peak on-state current (full cycle, $t_p=20ms$ , $T_j=25^\circ C$ )	$I_{TSM}$	40	A
Non repetitive surge peak on-state current (full cycle, $t_p=16.6ms$ , $T_j=25^\circ C$ )		44	
$I^2t$ value for fusing ( $t_p=10ms$ , $T_j=25^\circ C$ )	$I^2t$	8	$A^2s$
Critical rate of rise of on-state current ( $I_G=2 \times I_{GT}$ , $f=100Hz$ , $T_j=125^\circ C$ )	$di/dt$	100	$A/\mu s$
Peak gate current ( $t_p=20\mu s$ , $T_j=125^\circ C$ )	$I_{GM}$	4	A
Average gate power dissipation ( $T_j=125^\circ C$ )	$P_{G(AV)}$	0.5	W
Peak gate power	$P_{GM}$	10	W

Peak pulse voltage ( $T_j=25$ ; non-repetitive, off-state; FIG.7)	$V_{pp}$	3.5	kV
--	----------	-----	----

**ELECTRICAL CHARACTERISTICS** ( $T_j=25$  unless otherwise specified)

Symbol	Test Condition	Quadrant	Value		Unit
$I_{GT}$	$V_D=12V$ $R_L=33$	- -	MAX.	25	mA
$V_{GT}$		- -	MAX.	1	V
$V_{GD}$	$V_D=V_{DRM}$ $T_j=125$ $R_L=3.3k$	- -	MIN.	0.2	V
$I_L$	$I_G=1.2I_{GT}$	-	MAX.	40	mA
				60	
$I_H$	$I_T=100mA$		MAX.	35	mA
$dV/dt$	$V_D=670V$ Gate Open $T_j=125$		MIN.	1500	V/ $\mu s$
$(dI/dt)_c$	$(dV/dt)_c=20V/\mu s$ , $T_j=125$		MIN.	8	A/ms
$t_{on}$	$I_G=40mA$ $I_A=200mA$ $I_R=20mA$ $T_j=25$		TYP.	5	$\mu s$
$t_{off}$				70	
$V_{CL}$	$I_{CL}=0.1mA$ $t_p=1ms$		MIN.	1050	V

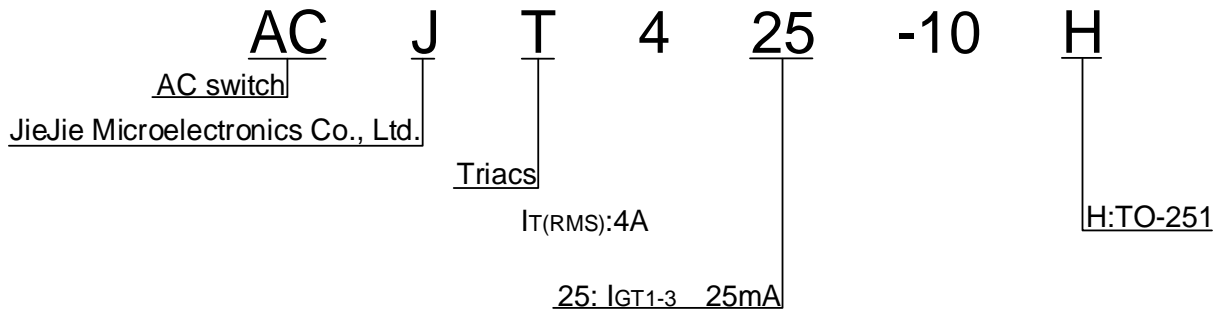
**STATIC CHARACTERISTICS**

Symbol	Parameter		Value(MAX.)	Unit
$V_{TM}$	$I_{TM}=5.6A$ $t_p=380\mu s$	$T_j=25$	1.55	V
$V_{TO}$	Threshold voltage	$T_j=125$	0.73	V
$R_D$	Dynamic resistance	$T_j=125$	171	m
$I_{DRM}$	$V_D=V_{DRM}$ $V_R=V_{RRM}$	$T_j=25$	8	$\mu A$
$I_{RRM}$		$T_j=125$	0.4	mA

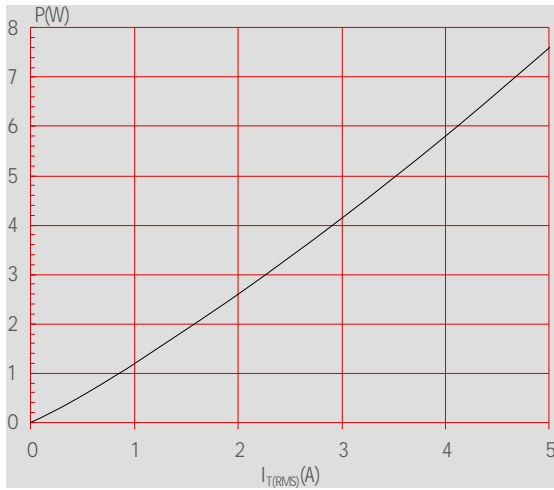
**THERMAL RESISTANCES**

Symbol	Parameter	Value	Unit
$R_{th(j-c)}$	junction to case (AC)	4.5	$^{\circ}W$
$R_{th(j-a)}$	junction to ambient (AC)	120	$^{\circ}W$

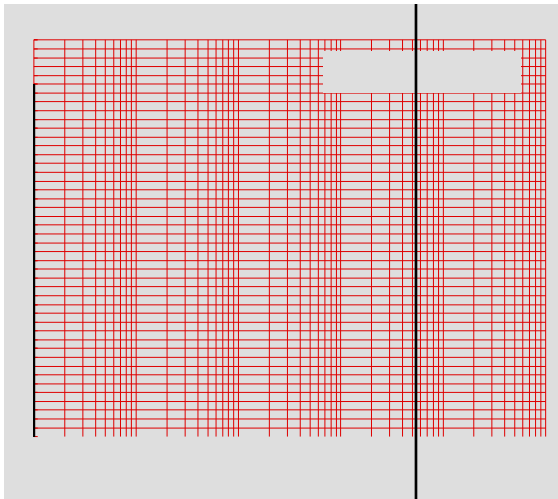
ORDERING INFORMATION



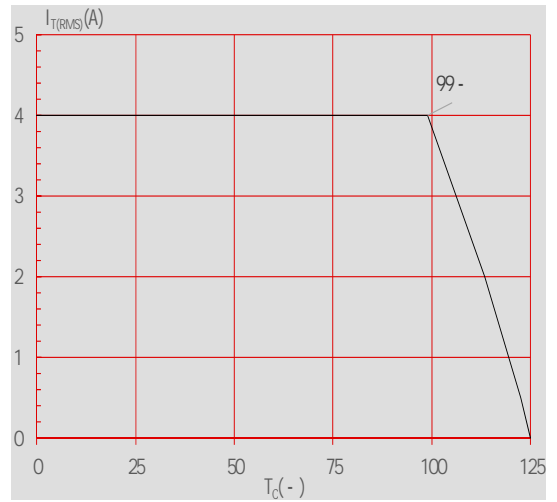
**FIG.1:** Maximum power dissipation versus RMS on-state current



**FIG.3:** Surge peak on-state current versus number of cycles

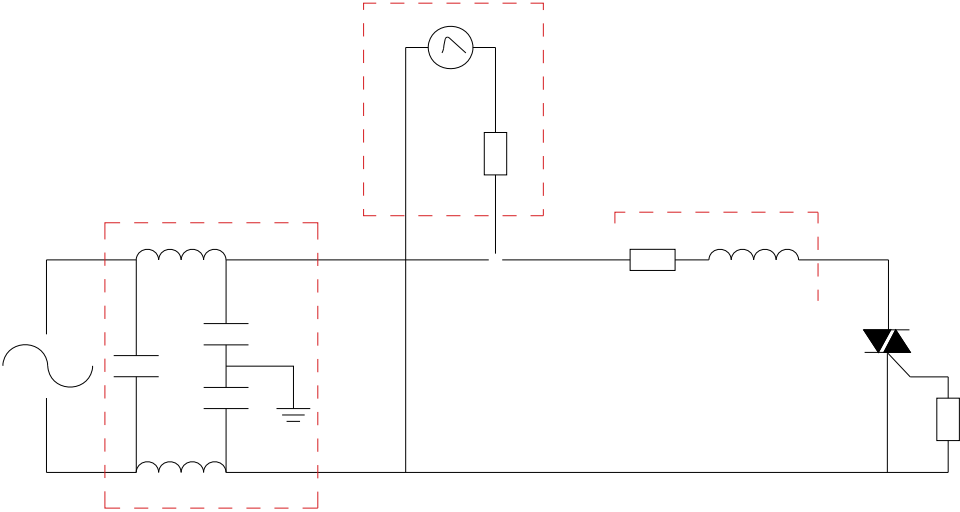


**FIG.2:** RMS on-state current versus case temperature



**FIG.4:** On-state characteristics

FIG.7 Test circuit for inductive and resistive loads to IEC-61000-4-5 standards



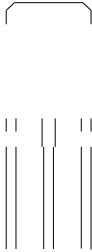
## ORDERING INFORMATION

Order code	Voltage $V_{DRM}/V_{RRM}$ (V)	IGT(mA)	Package	Base qty. (pcs)	Delivery mode
ACJT425-10H	1000	25	TO-251	80	Tube

## Document Revision History


Date	Revision	Changes
Apr.14, 2023	A.1.0	Last updated
Oct.20, 2025	A.1.1	Revise PACKAGE MECHANICAL DATA

PACKAGE MECHANICAL DATA



Information furnished in this document is believed to be accurate and reliable. However, Jiangsu JieJie Microelectronics Co., Ltd. assumes no responsibility for the consequences of use without consideration for such information nor use beyond it. Information mentioned in this document is subject to change without notice, apart from that when an agreement is signed, Jiangsu JieJie complies with the agreement.

Products and information provided in this document have no infringement of patents. Jiangsu JieJie assumes no responsibility for any infringement of other rights of third parties which may result from the use of such products and information. This document supersedes and replaces all information previously supplied.

 is a registered trademark of Jiangsu JieJie Microelectronics Co., Ltd.  
Copyright © 2025 Jiangsu JieJie Microelectronics Co., Ltd. All rights reserved.