



---

The products are transistor opto-couplers in a SSOP4 package.

The device is a photoelectric coupler composed of light-emitting

diode and phototransistor. The products are widely used in

switching power supply, intelligent meter, industrial control,

measuring instruments, office equipment

á Wid ol,un

de ann



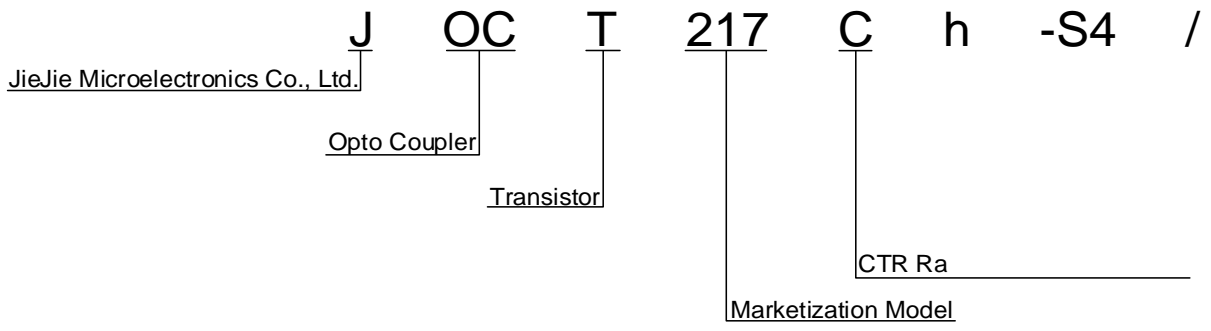





### Normalized Current Transfer Ratio vs. Ambient Temperature

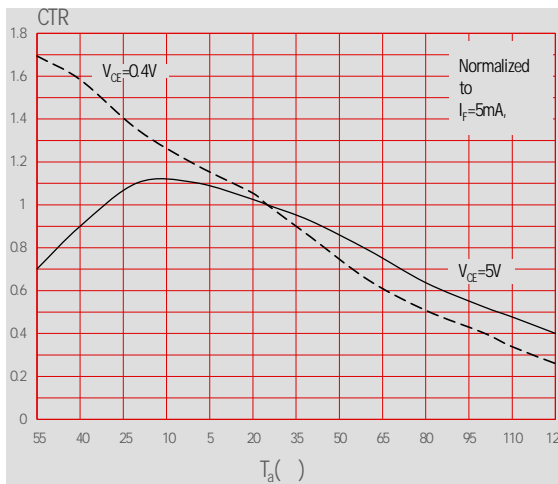

### Normalized Collector-emitter Saturation Voltage vs. Ambient Temperature

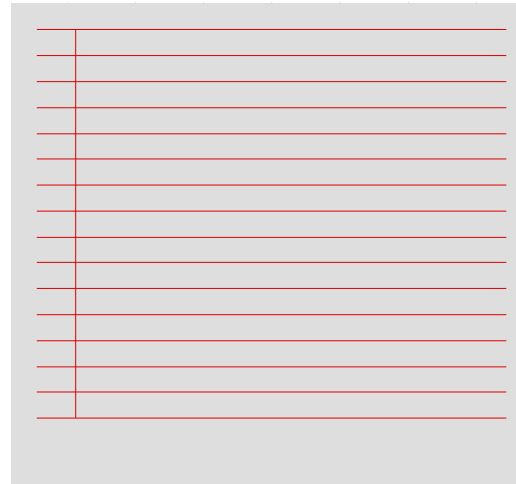



### Test Circuits of Response Time

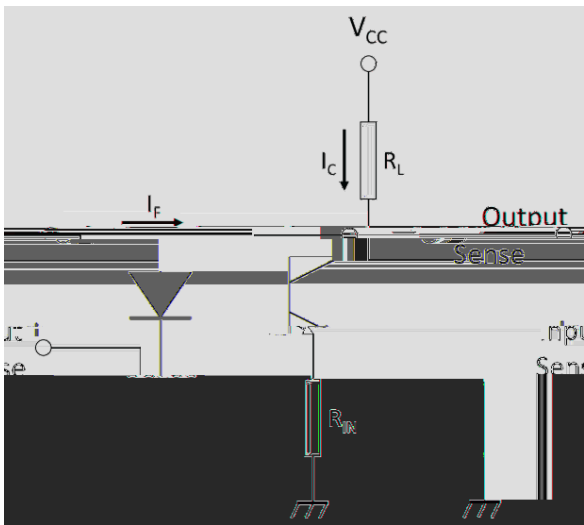

### Curves of Response Time

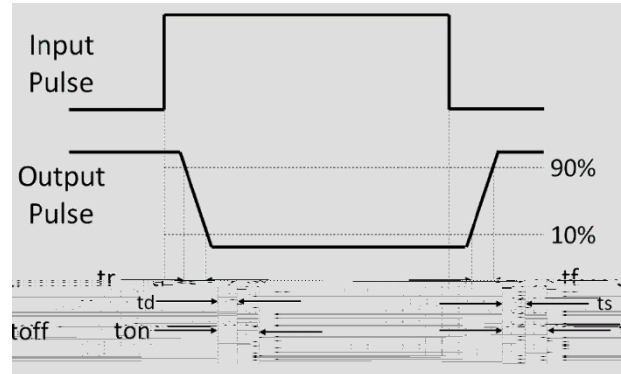

### Test Circuits of Frequency Response

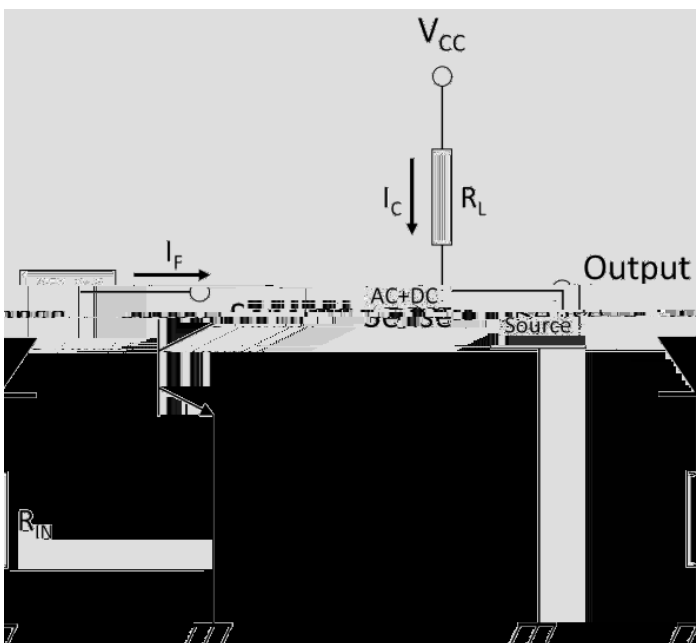

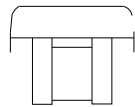
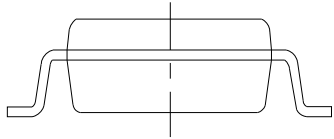
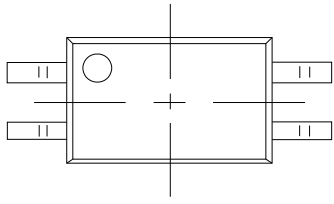



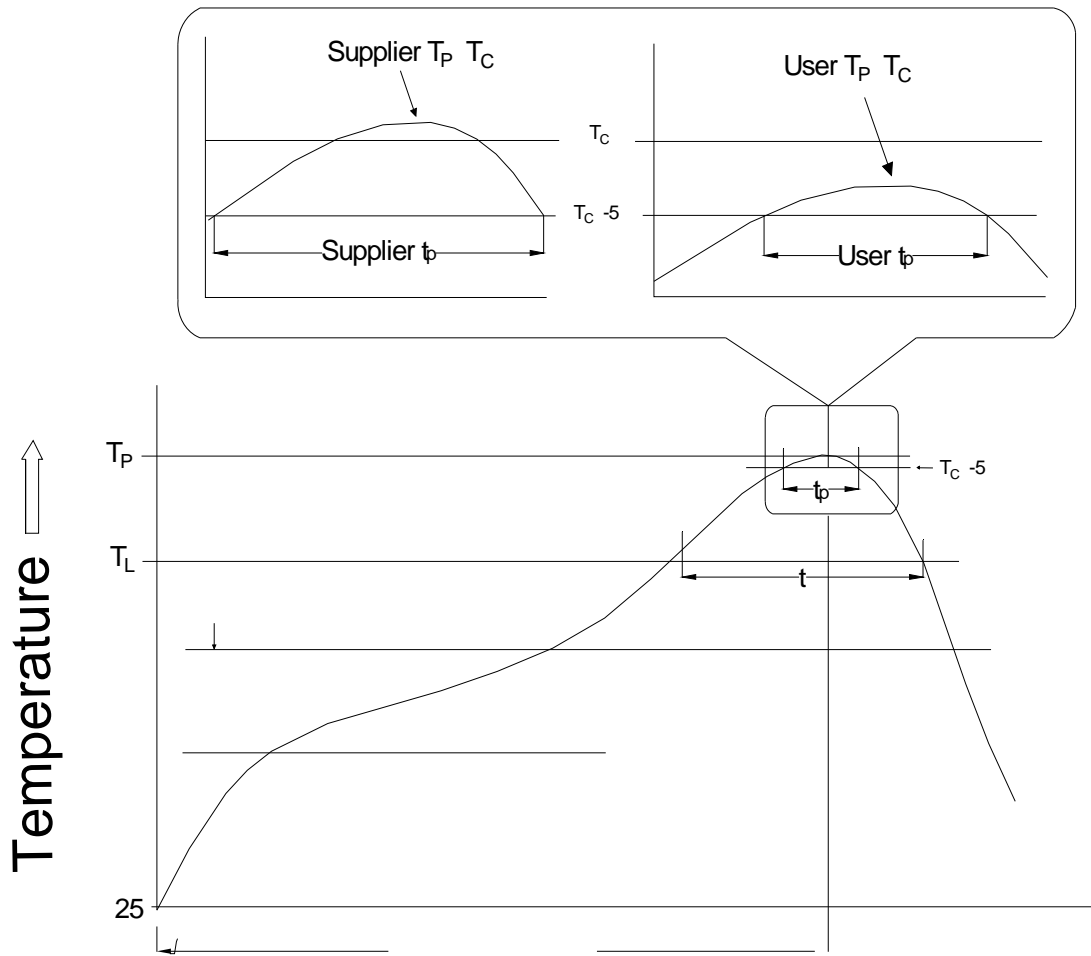



---

Note:

1. Reflow soldering is recommended at the temperatures and times shown, no more than three times.
2. Avoid direct contact between the epoxy body and any tools or surfaces exceeding its maximum storage temperature.
3. Application of pressure on the epoxy body is prohibited at elevated temperatures. In specific scenarios, any applied force must not exceed 2.5N.
4. Ensure the component has cooled to ambient temperature before proceeding with any subsequent manufacturing steps.
5. The component has a shelf life of one year when stored under standard conditions.
6. Recommend storage Temp.: 0~40°C;  
Recommend storage humidity: <60%;  
MSL level: MSL 1

Information furnished in this document is believed to be accurate and reliable. However, Jiangsu JieJie Microelectronics Co., Ltd. assumes no responsibility for the consequences of use without consideration for such information nor use beyond it. Information mentioned in this document is subject to change without notice, apart from that when an agreement is signed, Jiangsu JieJie complies with the agreement.

Products and information provided in this document have no infringement of patents. Jiangsu JieJie assumes no responsibility for any infringement of other rights of third parties which may result from the use of such products and information. This document supersedes and replaces all information previously supplied.

 is a registered trademark of Jiangsu JieJie Microelectronics Co., Ltd.

Copyright © 2026 Jiangsu JieJie Microelectronics Co., Ltd. All rights reserved.