



DESCRIPTION:



MAIN FEATURES:

ABSOLUTE MAXIMUM RATINGS

Parameter		Symbol	Value	Unit
)		
)		
)		
)		

ORDERING INFORMATION

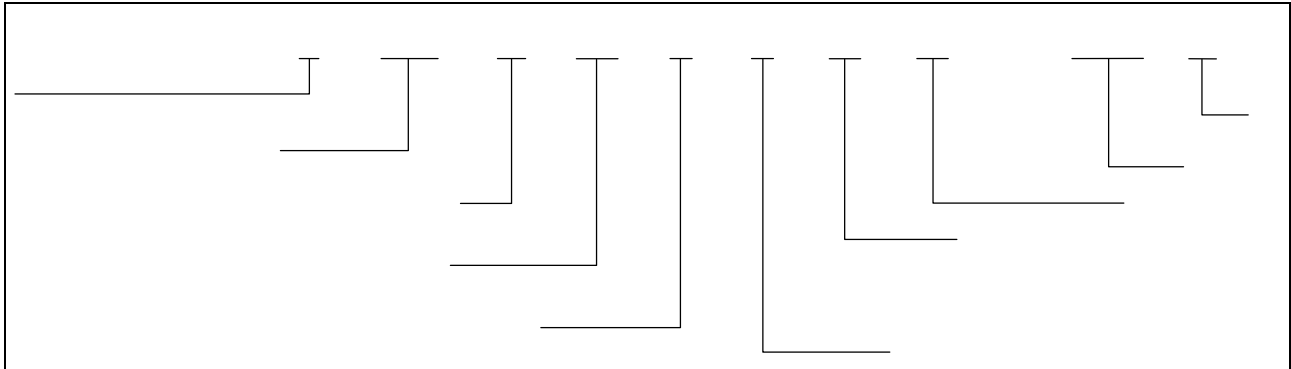

Packing Quantity	
Option	Quantity
DIP	0 Units/Tube
SMD	1200 Units/Reel

MARKING

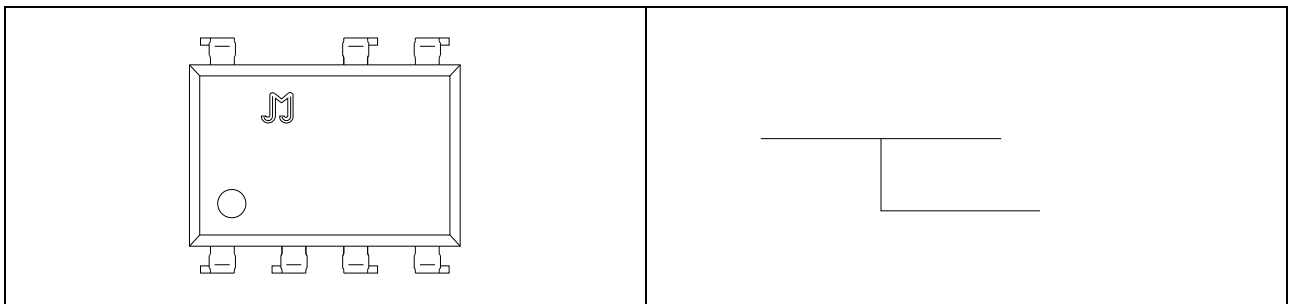

Characteristics Curves

FIG.1:

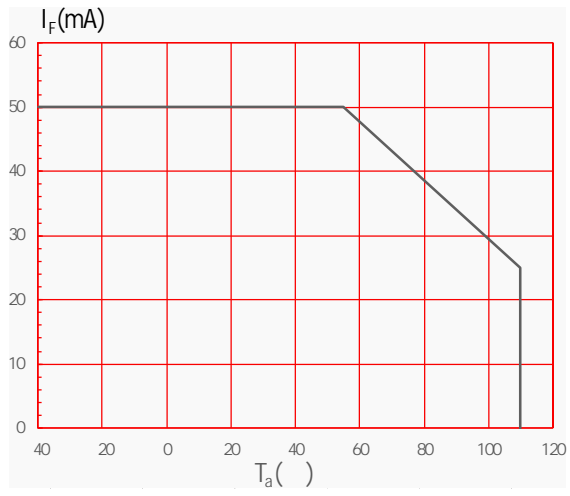

FIG.2:



FIG.7:

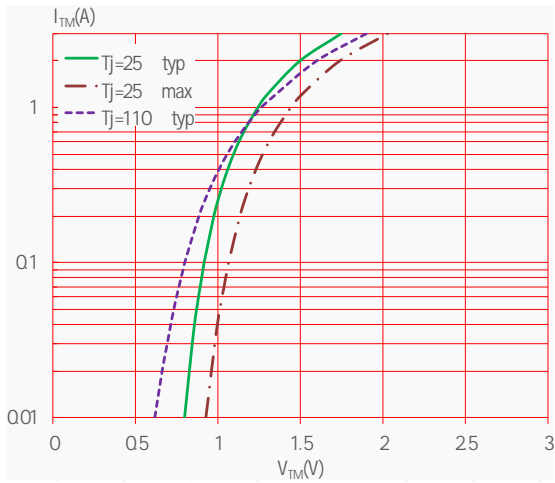
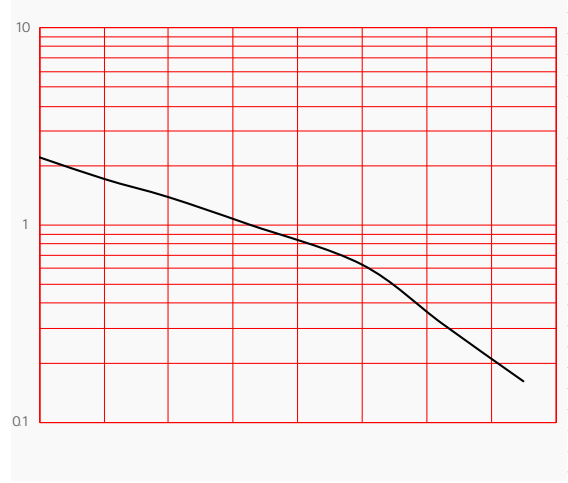

FIG.8:



TEST CIRCUITS

FIG.10:

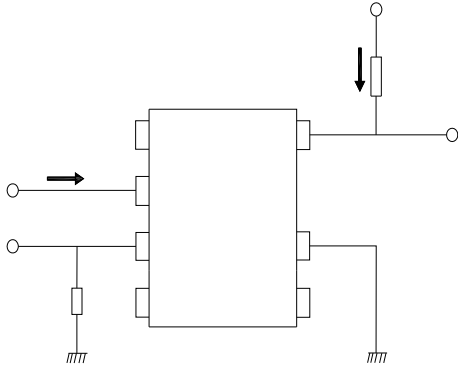
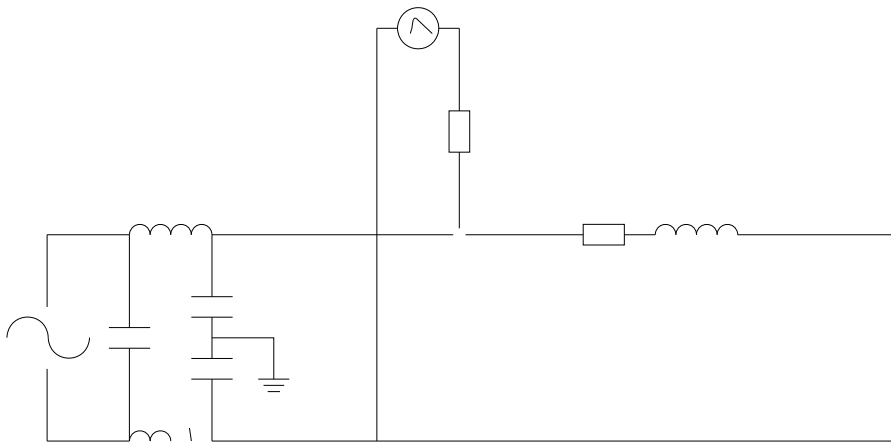

FIG.11:

FIG.12:

5 F H



RECOMMENDED SOLDER MASK (Dimensions in mm unless otherwise stated)

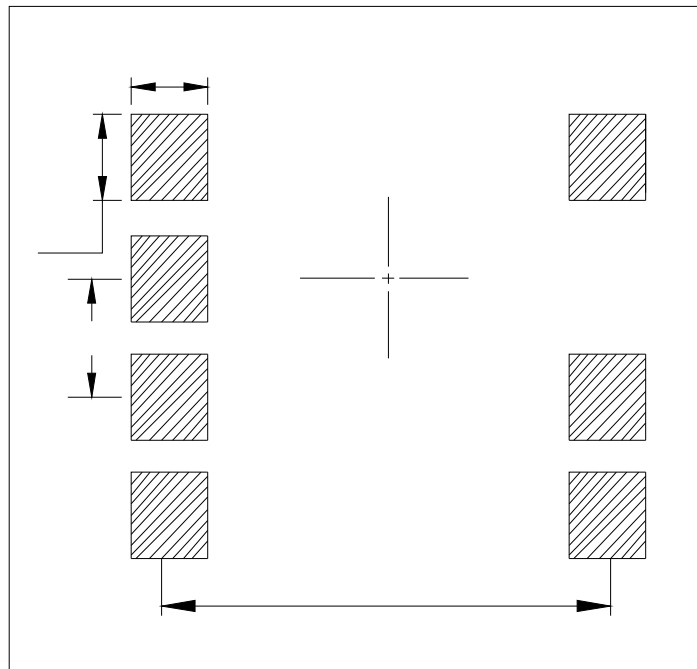

TUBE SPECIFICATIONS (Dimensions in mm unless otherwise stated)

Standard DIP

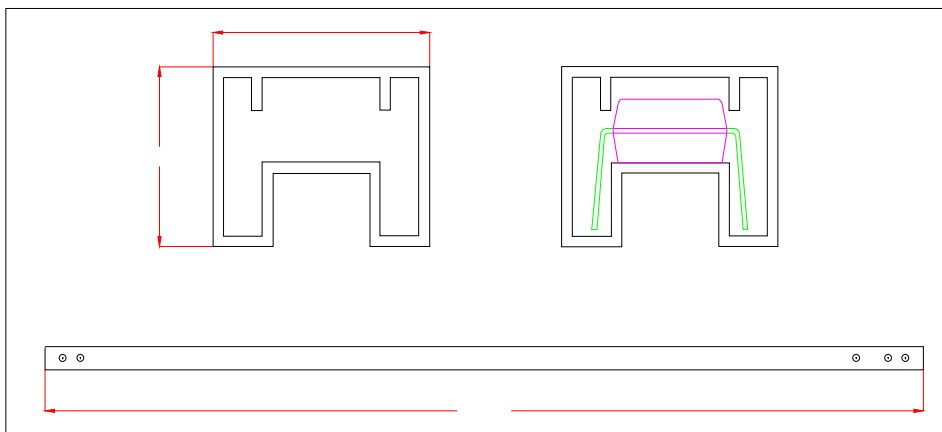

CARRIER TAPE SPECIFICATIONS (Dimensions in mm unless otherwise stated)

Option S/L

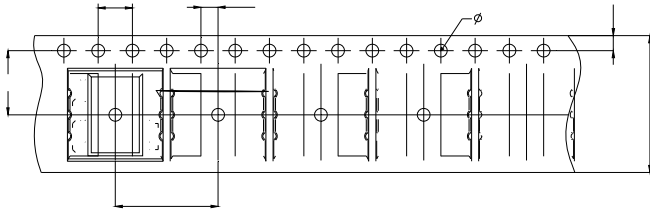

REFLOW INFORMATION

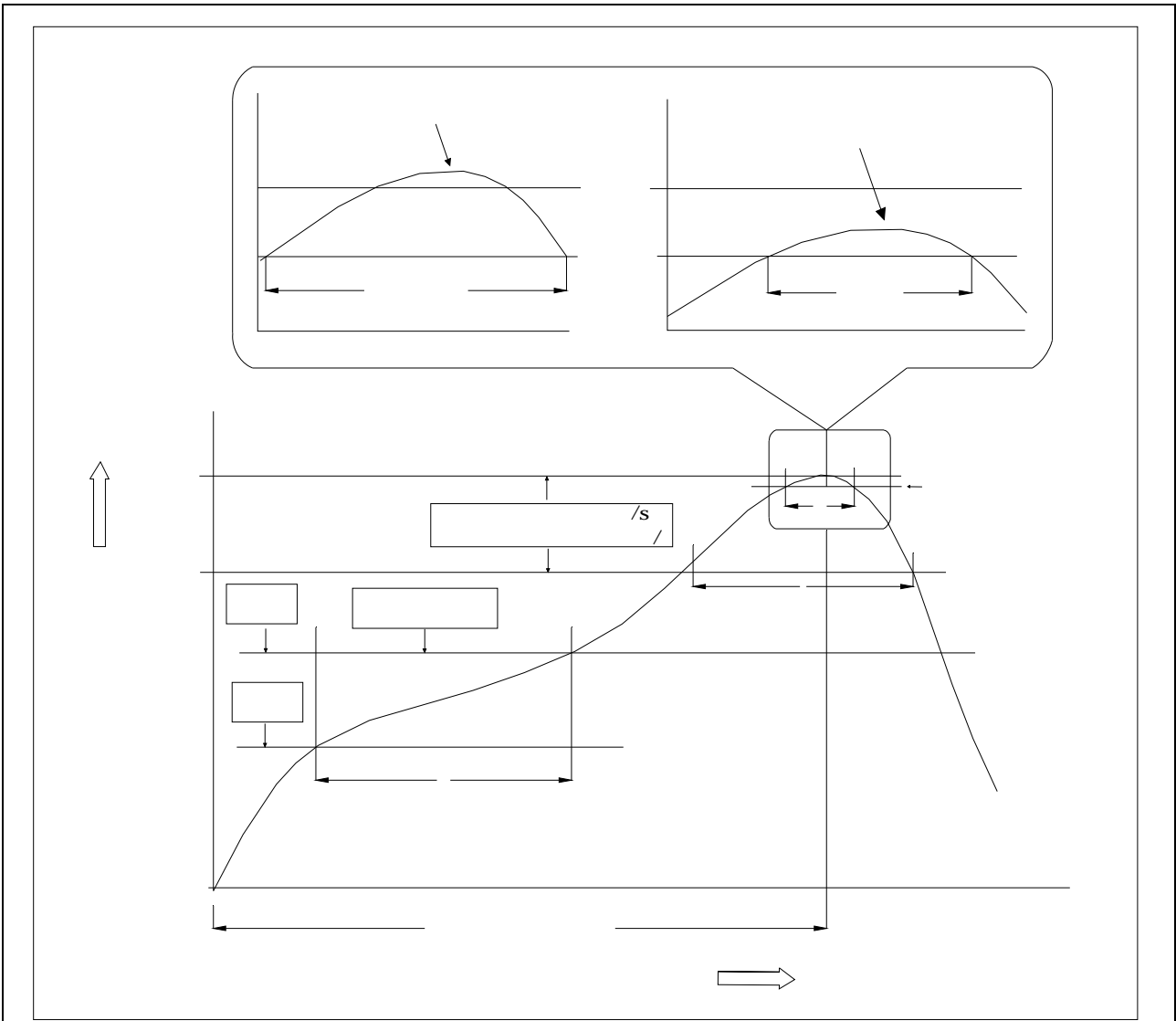

WAVE SOLDERING

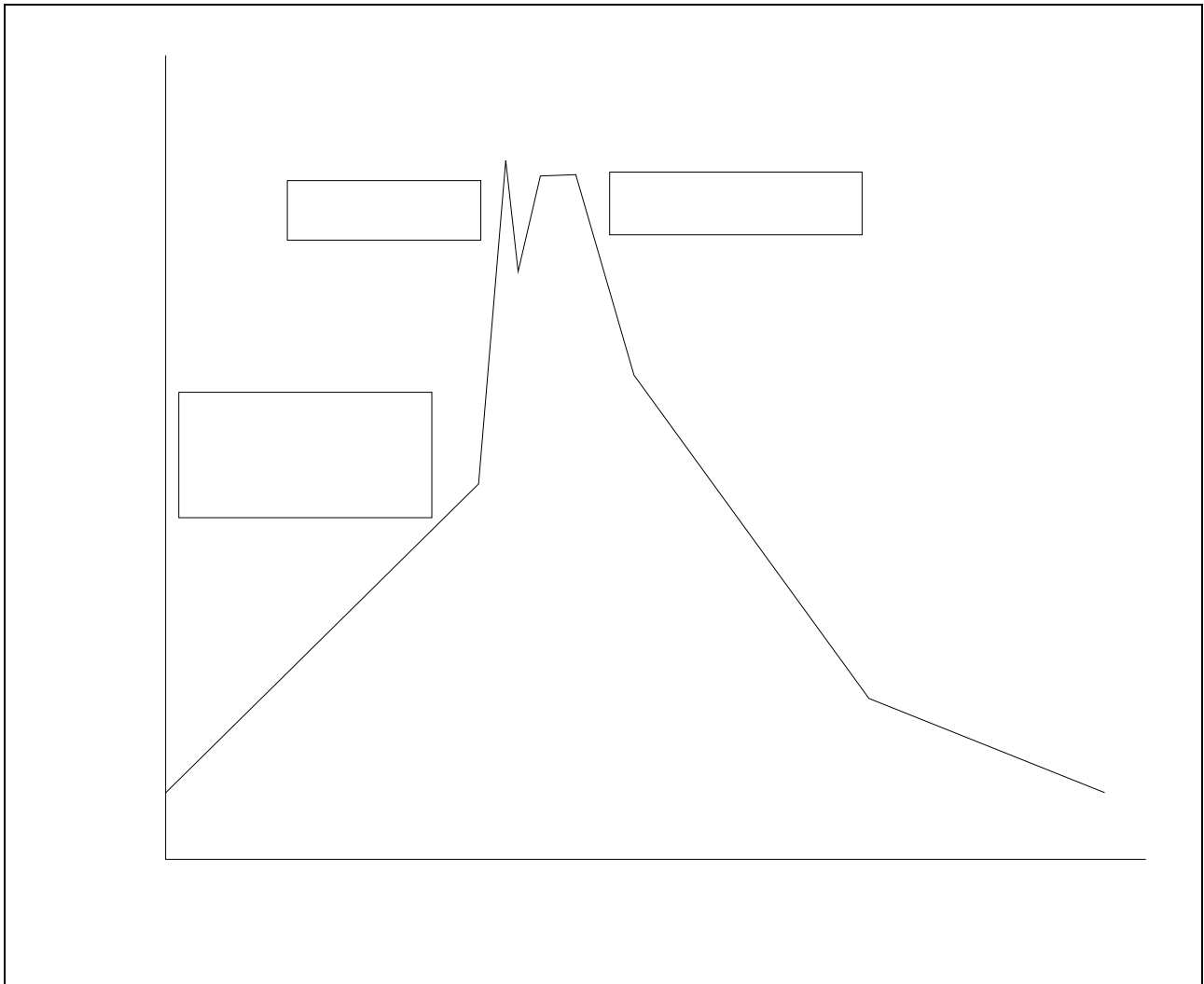

HAND SOLDERING BY SOLDERING IRON

±

